



## Product Specification Sheet

### BuzziChandelier EU

— By Sas Adriaenssens

#### An eye-catching lighting solution

Make a statement with your lighting by opting for the BuzziChandelier. A contemporary take on the classic chandelier. The perfect way to add atmosphere to your room with artful shadows and softened sounds. BuzziChandelier is an ideal design statement and acoustical solution for offices, restaurants, hotels, institutions, residences and more.



# The Family

## Models

**BuzziChandelier**

**BuzziChandelier Plain**

Lighting Units

**2G11 LED Bulb**  
(bulb included)

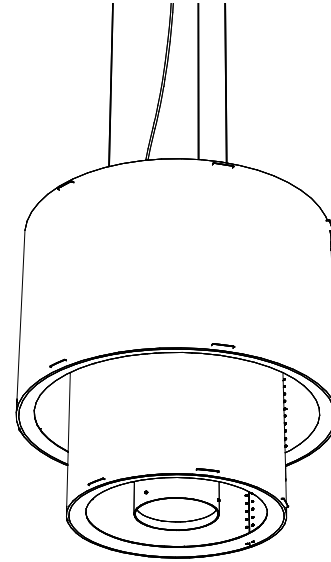
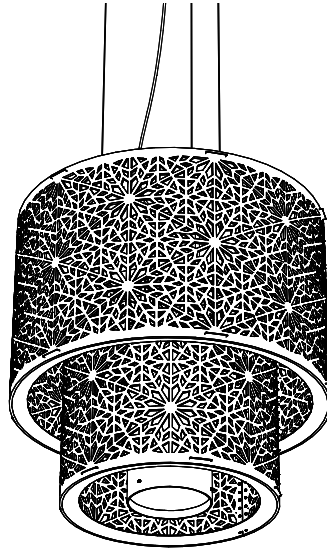

---

Required order information

1. Model
2. Color BuzziFelt or Pattern BuzziFelt Printed
3. Mounting Option

# Lighting Data

---

## Lighting Units

Retrofit Lighting unit

2G11 LED Bulb included



**BuzziChandelier | BuzziChandelier Plain**

Lighting Unit	Voltage	Wattage	Light Output Luminaire	Efficacy (Lm/W)	CRI	Dimming	Color Temperature	UGR	Standard (stock) On request (>LT)	Color Power Cable	Color Ceiling Canopy	Color Metal Frame	Fabric Collection	Fabric Color	Mounting Option
Retrofit 2G11 LED bulb incl.	220 - 240V	24 W	3200 Lm	133	83	-	3000K	-	Standard	Black	Black	Black	Use color codes below	Use color codes below	3 cables of 2 m or 5 m Alu or Black



CE CB

# Product Data

## Fixing System

### Fixing System Acoustic Panel

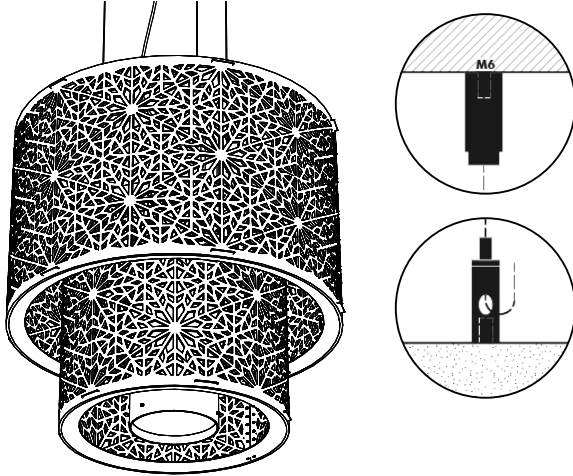

BuzziChandelier is suspended on 3 cables of 2 – 5 m black or alu colored cables, with fixing system screw.

⚠ If installing on suspended ceiling, verify load capacity prior to installation.

## Acoustic Shade



The acoustic shade consists of one layer of BuzziFelt with push snaps.

Shade in BuzziFelt or Offwhite BuzziFelt Printed (outside) in Gold, Emperador or Carrara.



Absorption



Diffusion



Mid tone



High tone

# Acoustics

## BuzziChandelier

### Equivalent sound absorption area in m<sup>2</sup> per object

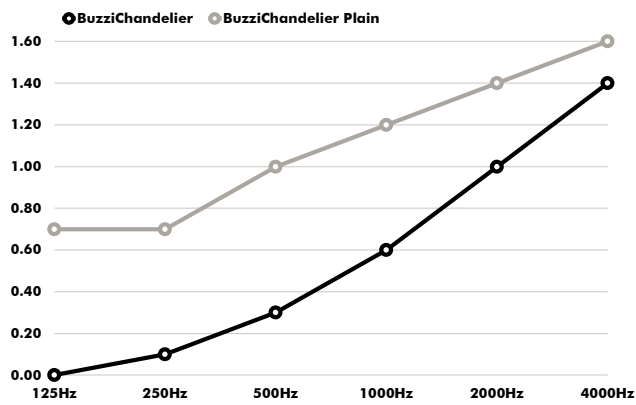

Hz	Aeq/m <sup>2</sup>	Plain Aeq/m <sup>2</sup>
125	0,0	0,7
250	0,1	0,7
500	0,3	1
1000	0,6	1,2
2000	1,0	1,4
4000	1,4	1,6

# Dimensions

## BuzziChandelier

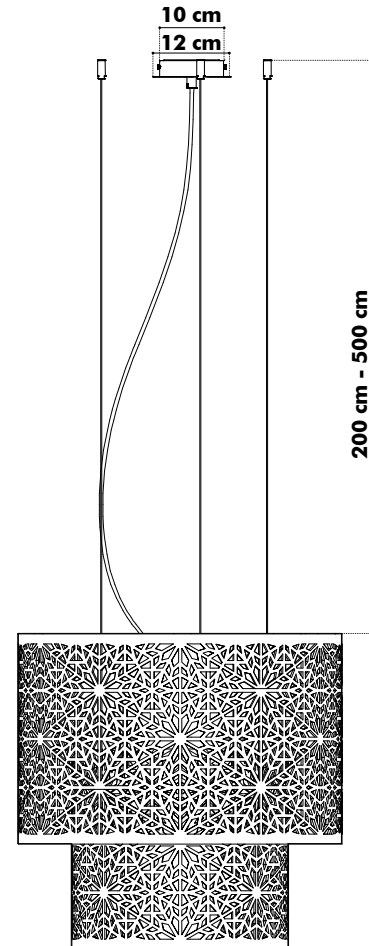
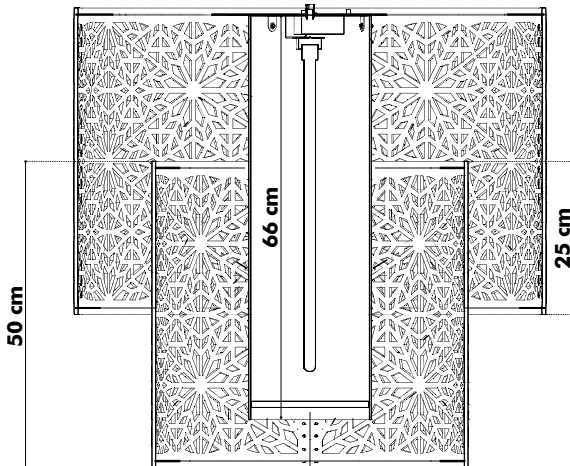
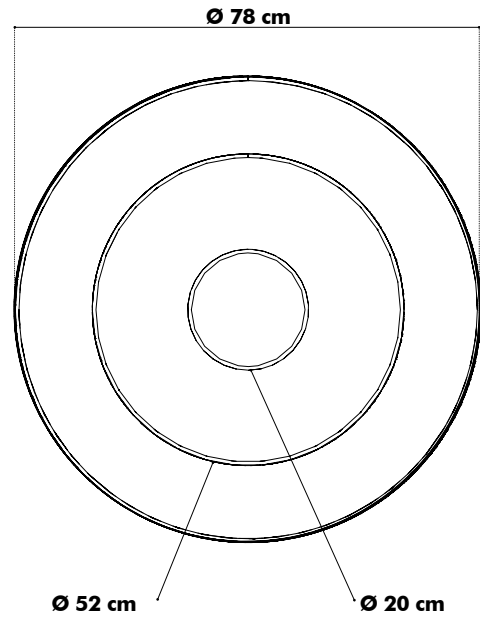
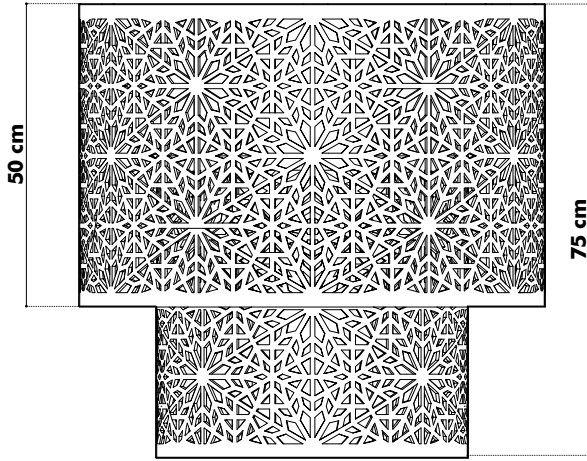

---

## Acoustics

### BuzziChandelier

Equivalent sound absorption area in m<sup>2</sup> per object

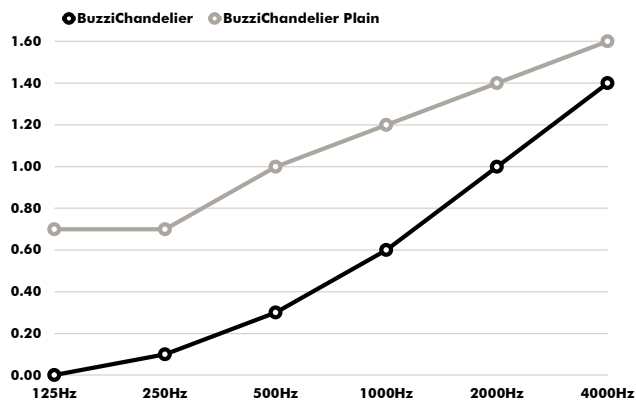

Hz	Aeq/m <sup>2</sup>	Plain Aeq/m <sup>2</sup>
125	0,0	0,7
250	0,1	0,7
500	0,3	1
1000	0,6	1,2
2000	1,0	1,4
4000	1,4	1,6

---

## Weights

### BuzziChandelier

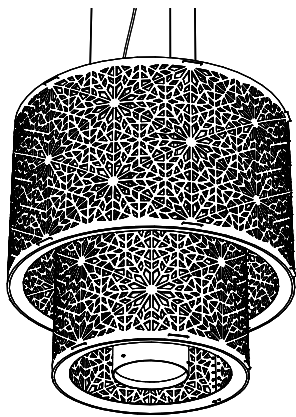

10,5 kg



# Fabrics

---

## Felt (12 colors)

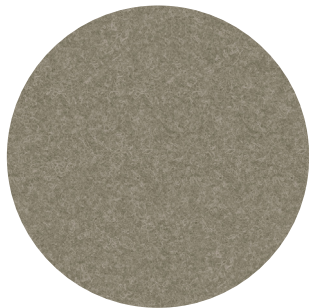

**Composition** 100% Recycled PE.T. Felt  
**Weight** 1.000 g/m2 | 29.49 oz/yd2  
**Abrasion resistance** >7.000 Martindale  
**Flammability** EU: EN 13501.1+A1/2009  
BS476 Part 6 and 7 Class 0  
USA: ASTM E84 Class A certified  
**Fastness to light** USA 5



---

## Felt OffWhite Printed

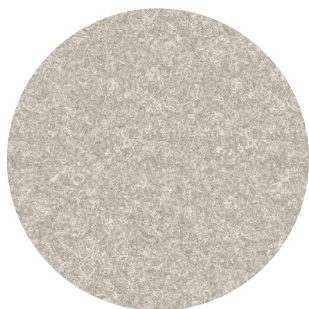

**Composition** 100% Recycled PE.T. Felt  
**Weight** 1.000 g/m2 | 29.49 oz/yd2  
**Abrasion resistance** >7.000 Martindale  
**Flammability** EU: EN 13501.1+A1/2009  
BS476 Part 6 and 7 Class 0  
USA: ASTM E84 Class A certified  
**Fastness to light** USA 5



Gold

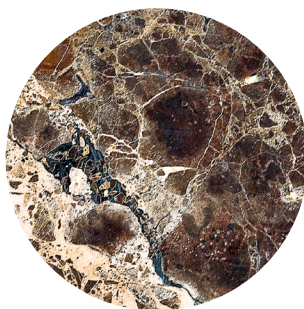

Emperor



Carrara