

zilenziO



Product sheet



Dezibel Divider



Dezibel

Divider absorber



Dezibel Divider is a sound-absorbing module that can be combined in many ways. The absorbers are suspended separated by 60 mm (2.4") or 100 mm (3.9"). Suspend it from the ceiling to create space separators and effective sound barriers. Dezibel Divider makes it possible to create separate areas and a very pleasant sound environment while preserving the room's openness.

DEZIBEL

Ceiling absorber

Sizes

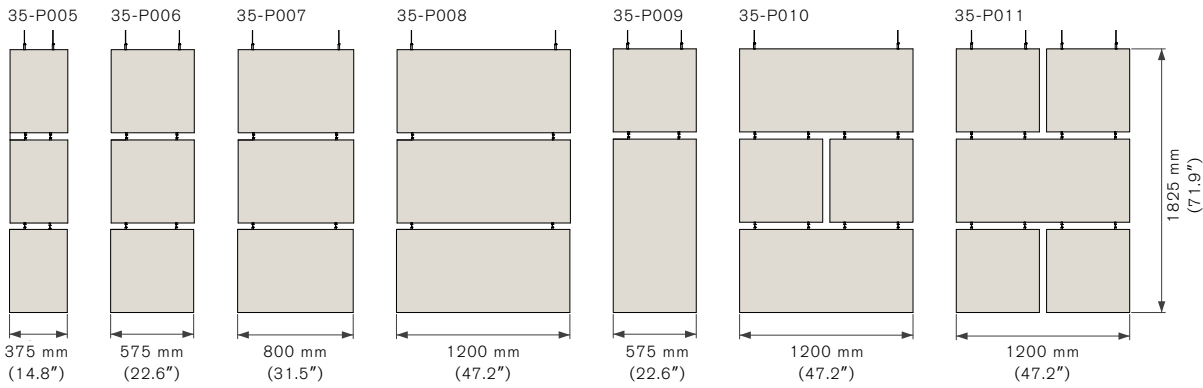
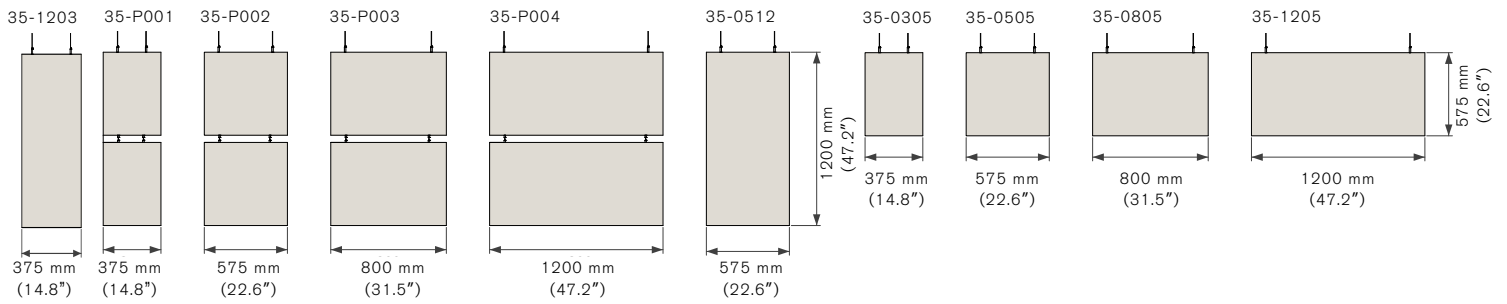

DIMENSIONS

35-0305	375 x 575 mm	(14.8" x 22.6")
35-0505	575 x 575 mm	(22.6" x 22.6")
35-0805	800 x 575 mm	(31.5" x 22.6")
35-1203	1200 x 375 mm	(47.2" x 14.8")
35-1205	1200 x 575 mm	(47.2" x 22.6")
35-0512	575 x 1200 mm	(22.6" x 47.2")
35-P001	375 x 1200 mm	(14.8" x 47.2")
35-P002	575 x 1200 mm	(22.6" x 47.2")
35-P003	800 x 1200 mm	(31.5" x 47.2")
35-P004	1200 x 1200 mm	(47.2" x 47.2")
35-P005	375 x 1825 mm	(14.8" x 71.9")
35-P006	575 x 1825 mm	(22.6" x 71.9")
35-P007	800 x 1825 mm	(31.5" x 71.9")
35-P008	1200 x 1825 mm	(47.2" x 71.9")
35-P009	575 x 1825 mm	(22.6" x 71.9")
35-P010	1200 x 1825 mm	(47.2" x 71.9")
35-P011	1200 x 1825 mm	(47.2" x 71.9")

Thickness 40 mm (1.6")

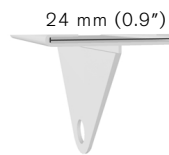

OPTIONAL

Ceiling bracket item no. 91-292

Wire 1500 mm (59.1") are included by default

Extra long wire: 3000 mm (118.1") item no. 90-059
 Extra long wire: 5000 mm (196.6") item no. 90-060

DESIGN

MDF frame. Stone wool filling with fire class A1 (non-combustible) 100% free from plastic and polyether. External cover of textile. To be mounted using cable and cable lock. Length of cable: 1500 mm (59.1"). A hook for ceiling fastening is not supplied.

DESIGNER

Zilenzio

ENVIRONMENT AND QUALITY

Approved according to Möbelfakta.

SOUND TESTS

SS-EN ISO 354, ISO 11654 Class A
 SS-EN ISO 354:2003 evaluated according to SS 25269

N10		
575 x 575 mm	(22.6" x 22.6")	15
1200 x 575 mm	(47.2" x 22.6")	9
1200 x 1825 mm	(47.2" x 71.9")	2

SPECIFICATION TEXT

Example: Dezibel Divider from Zilenzio
 Several sound absorbers hanging at 50 mm (2") intervals with filling of stone wool fire class A1 non-combustible. Covered around with fabric Remix from Kvadrat.

Technical specification:
 Size: 1200 x 1825 mm (47.2" x 71.9")
 Fabric: Remix 123 and 762 from Kvadrat



STANDARD FABRICS

We have a selection of standard fabrics with different characters.

Sawana	Davis Fabrics	Price group 1
Cara Carlow	Camira Fabrics	Price group 1
Event Screen +	Gabriel	Price group 1
Blazer Lite	Camira Fabrics	Price group 2
Floyd Screen	Kvadrat	Price group 2
Remix	Kvadrat	Price group 3
Blazer, Synergy	Camira Fabrics	Price group 3
Fiord, Melange Nap	Kvadrat	Price group 4

Request a quotation for other fabrics.

CARE INSTRUCTIONS

In order to preserve the color and appearance of the fabric, the fabric should be regularly vacuumed with a soft nozzle.

Stain Removal for Polyester:

- Moisten the stain sparingly with a white clean cotton cloth, lukewarm water and possibly some pH neutral detergent.

Stain Removal for Wool:

- Dot or gently wipe with a damp cloth.

NOTE! The following fabric colors are only a selection. For more colors see zilenzio.se

Color deviation can occur when viewing PDF and print. To see exact fabric colors, please order a sample from us.

SAWANA DAVIS FABRICS

PRICE GROUP 1

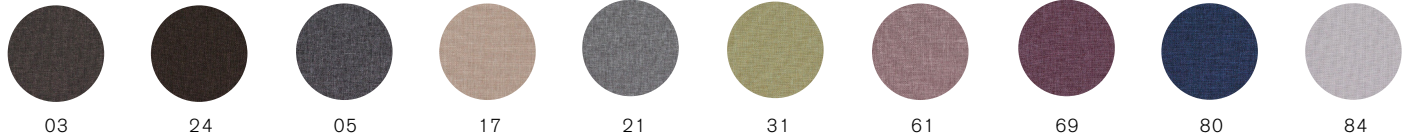

CARLOW CAMIRA FABRICS

PRICE GROUP 1

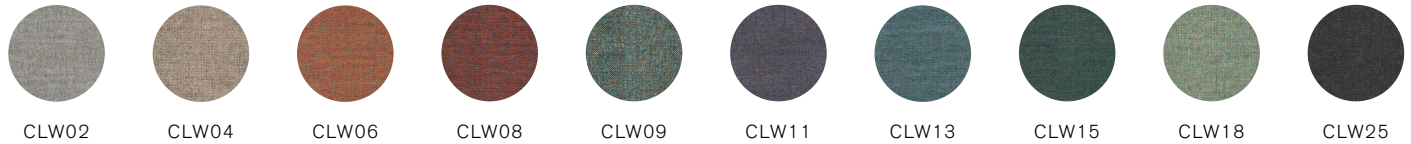

BLAZER LITE CAMIRA FABRICS

PRICE GROUP 2

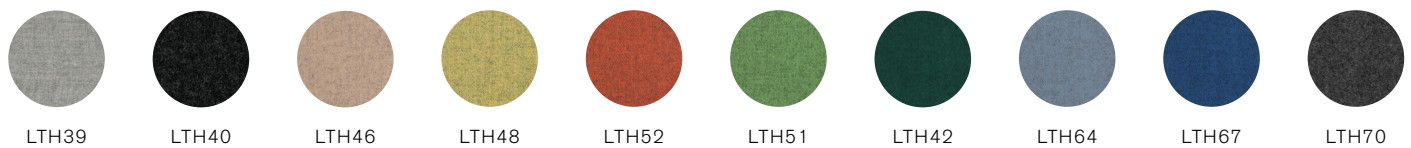

REMIX KVADRAT

PRICE GROUP 3

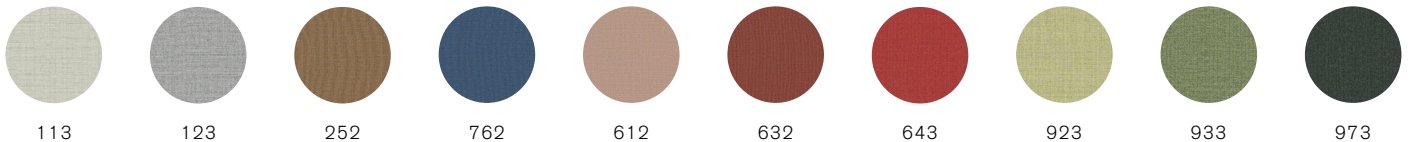

SYNERGY CAMIRA FABRICS

PRICE GROUP 3

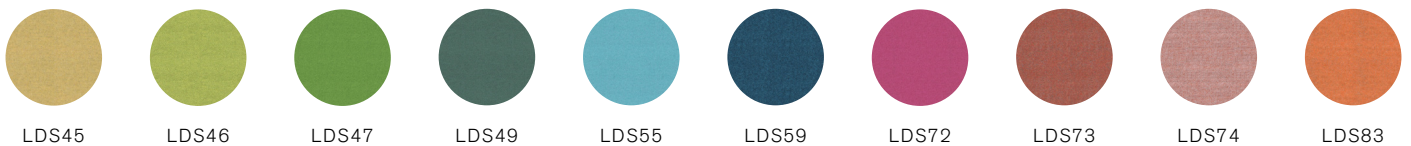

MELANGE NAP KVADRAT

PRICE GROUP 4

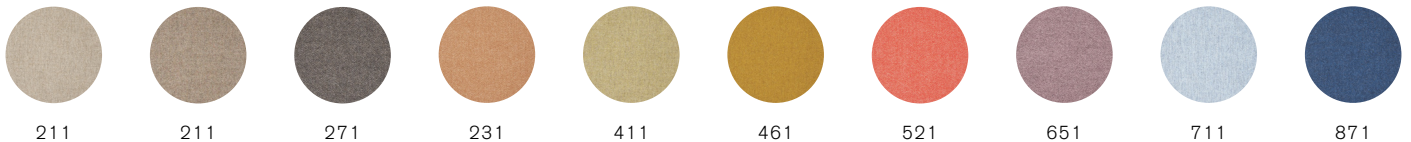

zilenzio

Head Office
Boställsvägen 6
702 27 Örebro Sweden

Phone: +46 19 672 17 00
Mail: info@zilenzio.se

www.zilenzio.com
Facebook: Zilenzio
Instagram: @zilenzio
© 2020 Zilenzio